



Agenda Item # 4

BOA-002775-2023

View additional details on this proposal and all application materials using the following link:

[Applicant Materials for Consideration](#)

DETAILS

Location:

164 St. Francis Street and 159 St. Michael Street

Applicant / Agent:

Jenny Olvera, Synovus

Property Owner:

Margaret Wright Martin and 164 St Francis LLC

Current Zoning:

T-5.2 Sub-District of the Downtown Development District

Future Land Use:

Downtown

Case Number(s):

6565

Unified Development Code Requirement:

- All new structures must have a compliant frontage type in a T-5.2 Sub-District of the Downtown Development District

Board Consideration:

- New freestanding ATM structure proposed with a non-compliant frontage type in a T-5.2 Sub-District of the Downtown Development District

Report Contents:

	Page
Context Map	2
Site History	3
Staff Comments	3
Variance Considerations	4
Exhibits	6

BOARD OF ADJUSTMENT VICINITY MAP - EXISTING AERIAL

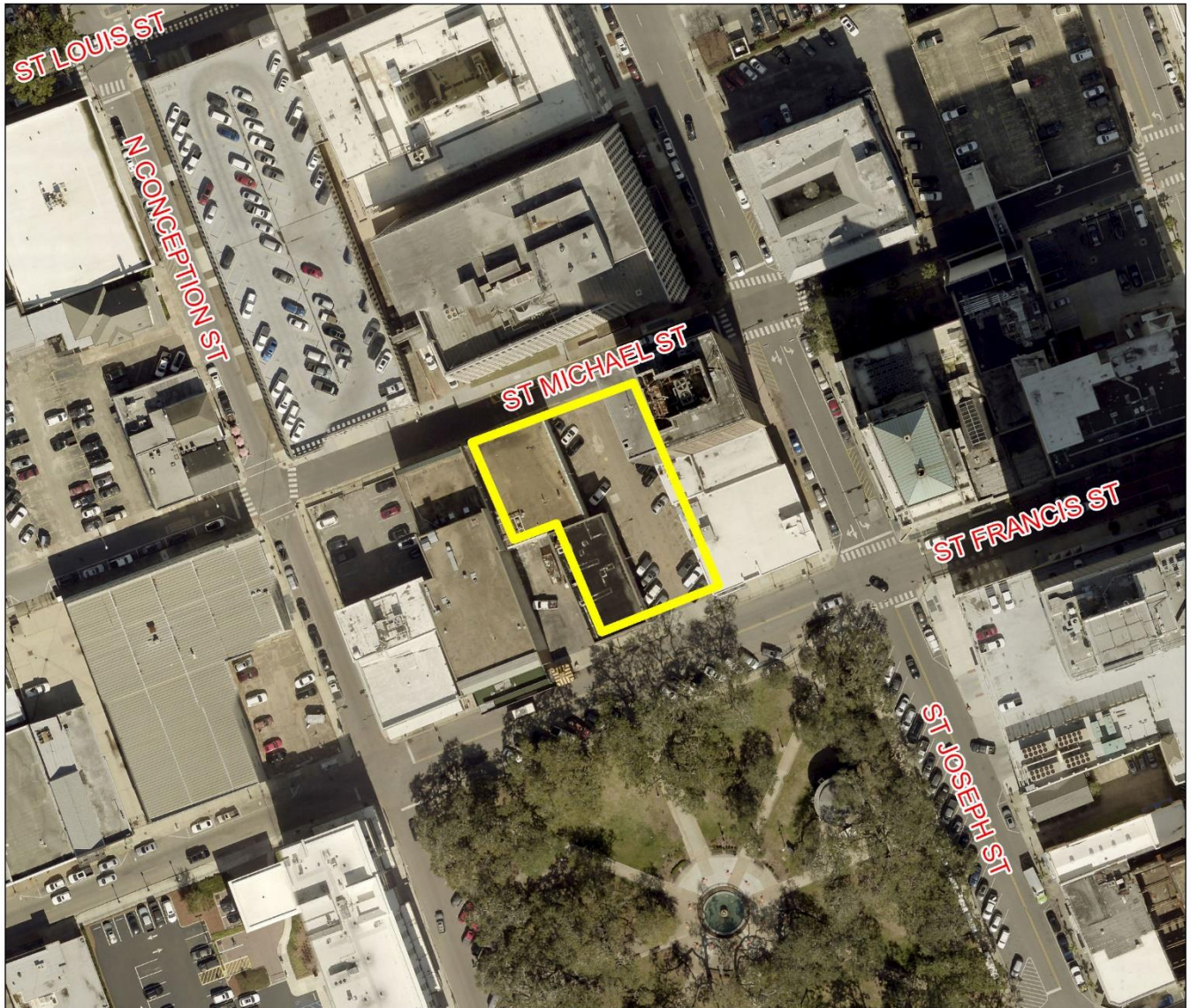

The site is surrounded by commercial units.

APPLICATION NUMBER	6565	DATE	January 8, 2024
APPLICANT	Jenny Olvera, Synovus		
REQUEST	Frontage Type Variance		



SITE HISTORY

The site has no history of applications before the Board of Adjustment or Planning Commission.

STAFF COMMENTS

Engineering Comments:

If the proposed variance is approved the applicant will need to have the following conditions met:

- The proposed improvements shown on the submitted plans will require a Land Disturbance Permit be submitted through Central Permitting.
- The existing drainage patterns and surface flow characteristics should not be altered so as to have a negative impact on any adjoining properties or any public rights-of-way.
- Any and all proposed land disturbing activity within the property will need to be in conformance with Mobile City Code, Chapter 17, Storm Water Management and Flood Control); the City of Mobile, Alabama Flood Plain Management Plan (1984); and, the Rules For Erosion and Sedimentation Control and Storm Water Runoff Control.
- Applicant agrees to install adequate BMPs during construction to protect from sediment/pollutants leaving the site.

Traffic Engineering Comments:

ATM Structure shall not obstruct the sidewalk. Any required on-site parking, including ADA handicap spaces, shall meet the minimum standards as defined in Appendix A, Section 9.C of the City's Unified Development Code.

Urban Forestry Comments:

Property to be developed in compliance with state and local laws that pertain to tree preservation and protection on both city and private properties [Act 929 of the 1961 Regular Session of the Alabama Legislature (Acts 1961, p. 1487), as amended, and City Code Chapters 57 and 65]. Private removal of trees in the right-of-way will require approval of the Mobile Tree Commission. Removal of heritage trees from undeveloped residential sites, developed residential sites in historic districts, and all commercial sites will require a tree removal permit.

Fire Department Comments:

All projects within the City Limits of Mobile shall comply with the requirements of the City of Mobile Fire Code Ordinance (2021 International Fire Code). Fire apparatus access is required to be within 150' of all non-sprinklered commercial buildings and within 300' of all sprinklered commercial buildings. Fire water supply for all commercial buildings will be required to meet the guidance of Appendices B and C of the 2021 International Fire Code. The minimum requirement for fire hydrants is to be within 400' of non-sprinkled commercial buildings, within 600' of sprinkled commercial buildings, and within 100' of fire department connections (FDC) for both standpipes and sprinkler systems.

Planning Comments:

The applicant has requested a Frontage Variance to allow a new freestanding ATM structure without a compliant frontage type in a T-5.2 Sub-District of the Downtown Development District; the Unified Development Code (UDC)

requires all new structures have a compliant frontage type in a T-5.2 Sub-District of the Downtown Development District.

The complete application and supporting documents are available via the link on page 1.

The existing structure at 164 St. Francis Street is occupied by a bank. The applicant wishes to place a new freestanding ATM structure in the existing parking lot at 159 St. Michael Street that will service pedestrians and also provide drive-up service for a single vehicle.

The applicant submitted a Consolidated Review Committee (CRC) application for the proposed development, and after the application was reviewed, the applicant was advised of the following:

- Parking screening is required to be provided in compliance with Appendix A, Section 9.C.2.(c). of the Unified Development Code (UDC);
- The proposed structure does not have a compliant frontage type as set forth in Appendix A, Section 10.C.4. of the Unified Development Code (UDC); and
- Proposed signage does not appear to comply with Appendix A, Section 11 of the Unified Development Code (UDC).

Since the CRC review, the applicant has revised the site plan to depict parking screening. The applicant has also stated that they are not seeking approval of signage at this time, and if needed, will submit a separate variance application for signage at a later date. It should be noted that the revised site plan with parking screening has not been reviewed by the CRC. Prior to the issuance of any related permits, revised site plans will need to be submitted to the CRC for approval.

As the proposed ATM structure is not a traditional building, it is difficult for it to comply with the various frontage standards set forth in the Downtown Development District (DDD) regulations. It should be noted that a similar variance was granted by the Board of Adjustment at its October 2021 meeting for a different freestanding ATM at 9 North Royal Street that provides walk-up only service, and did not include a roof enclosure.

VARIANCE CONSIDERATIONS

Standards of Review:

Variances are not intended to be granted frequently. The applicant must clearly show the Board that the request is due to very unusual characteristics of the property and that it satisfies the variance standards. What constitutes unnecessary hardship and substantial justice is a matter to be determined from the facts and circumstances of each application.

Article 5 Section 10-E. 1. of the Unified Development Codes states that the Board of Adjustment may grant a variance if:

- The Applicant demonstrates that the variance shall not be contrary to the public interest,
- Where, owing to special conditions a literal enforcement of the provision of this Chapter will result in unnecessary hardship; and
- The spirit of this Chapter will be observed and substantial justice done.

Article 5 Section 10-E.2. states no variance shall be granted:

- (a) In order to relieve an owner of restrictive covenants that are recorded in Mobile County Probate Court and applicable to the property;
- (b) Where economic loss is the sole basis for the required variance; or
- (c) Where the variance is otherwise unlawful.

Considerations:

Based on the requested Variance application and documentation submitted, if the Board considers approval of the request, the following findings of fact must be present:

- 1) The variance **will not** be contrary to the public interest;
- 2) Special conditions **exist** such that a literal enforcement of the provisions of the chapter **will** result in unnecessary hardship; and
- 3) The spirit of the chapter **shall be** observed and substantial justice **done** to the applicant and the surrounding neighborhood by granting the variance.

If approved, the following conditions should apply:

- 1) Submittal of a revised site plan for review to the Consolidate Review Committee (CRC).

LOCATOR ZONING MAP

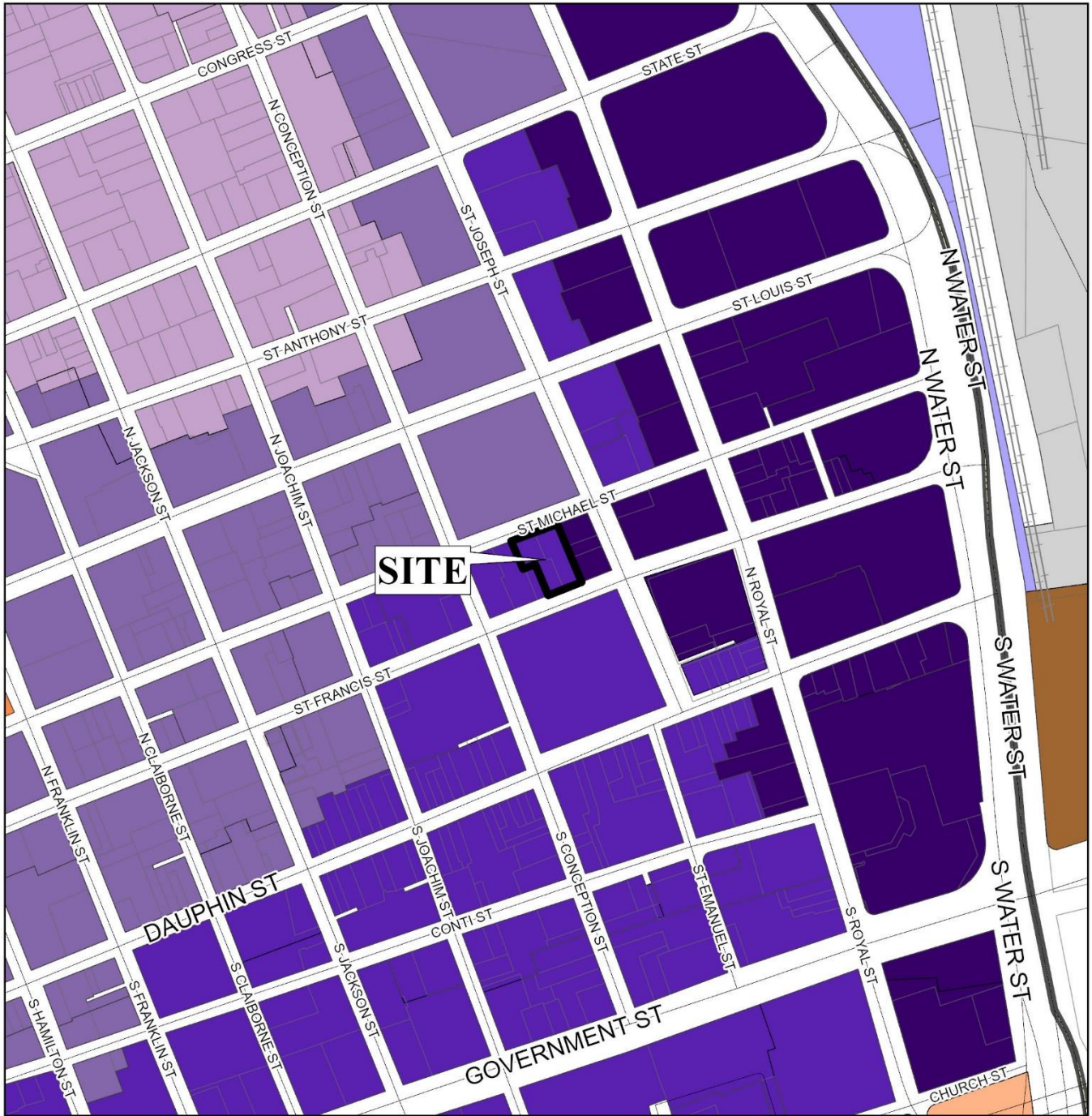

APPLICATION NUMBER 6565 DATE January 8, 2024

APPLICANT Jenny Olvera, Synovus

REQUEST Frontage Type Variance



NTS

FLUM LOCATOR MAP

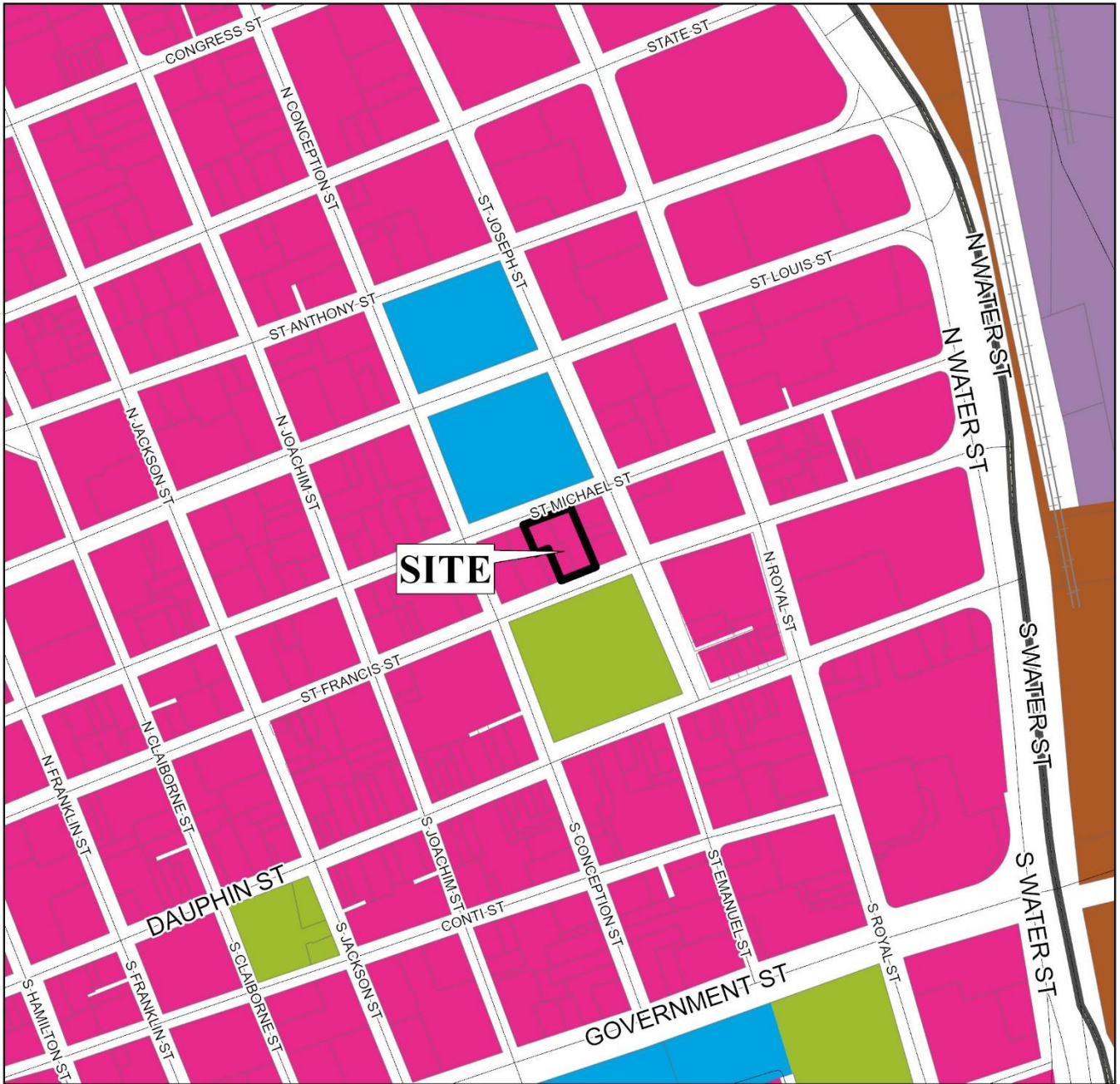

APPLICATION NUMBER 6565 DATE January 8, 2024

APPLICANT Jenny Olvera, Synovus

REQUEST Frontage Type Variance

- | | | | |
|---|--|---|--|
| ■ Low Density Residential | ■ Neighborhood Center - Traditional | ■ Downtown Waterfront | ■ Parks & Open Space |
| ■ Mixed Density Residential | ■ Neighborhood Center - Suburban | ■ Light Industry | ■ Water Dependent |
| ■ Downtown | ■ Traditional Corridor | ■ Heavy Industry | |
| ■ District Center | ■ Mixed Commercial Corridor | ■ Institutional | |



BOARD OF ADJUSTMENT VICINITY MAP - EXISTING ZONING

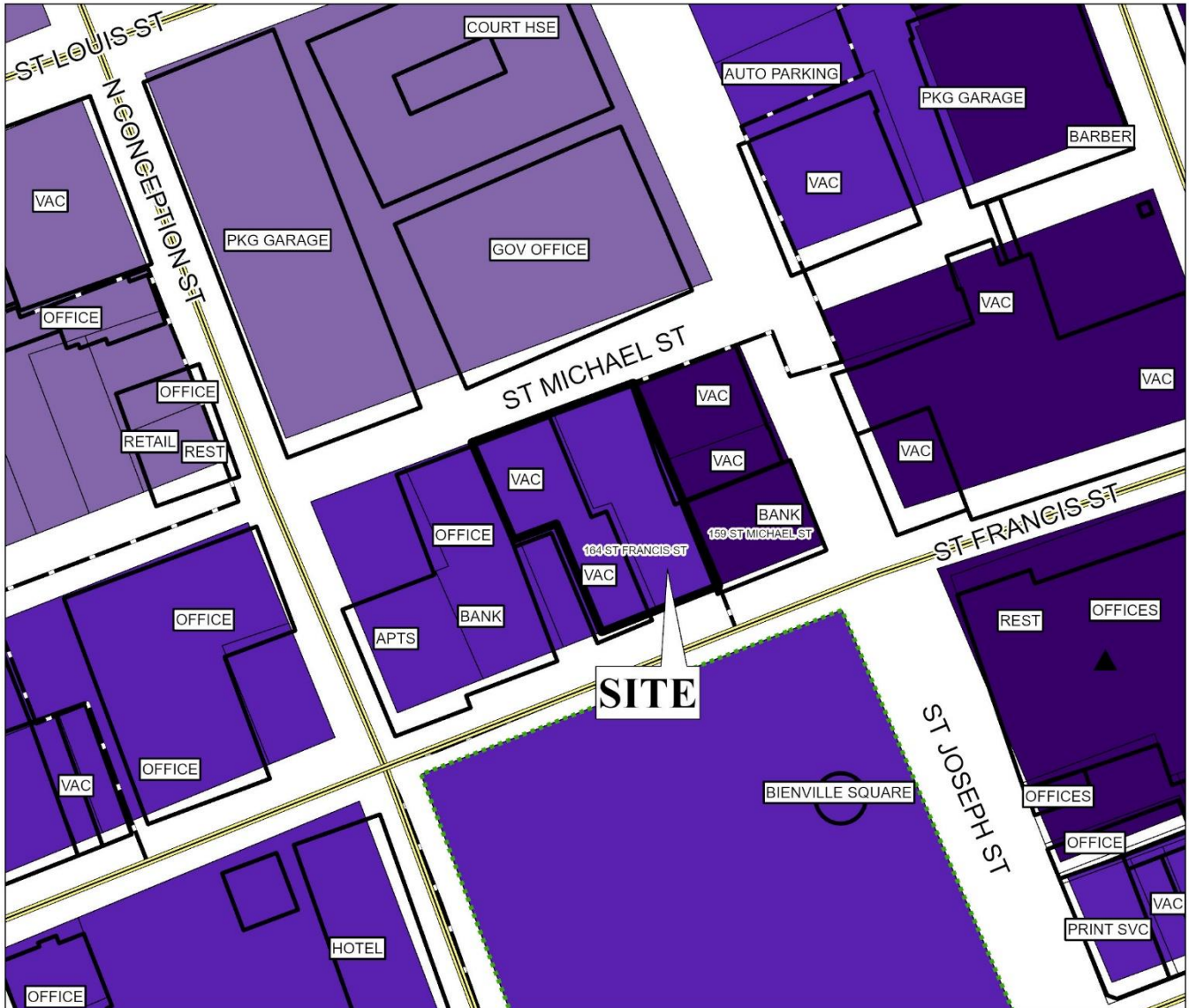

The site is surrounded by commercial units.

APPLICATION NUMBER	6565	DATE	January 8, 2024																														
APPLICANT	Jenny Olvera, Synovus																																
REQUEST	Frontage Type Variance																																
<table style="width: 100%; font-size: small;"> <tr> <td style="background-color: #e0ffff; border: 1px solid black;">R-A</td> <td style="background-color: #00ff00; border: 1px solid black;">R-3</td> <td style="background-color: #00bfff; border: 1px solid black;">B-1</td> <td style="background-color: #ffa500; border: 1px solid black;">B-2</td> <td style="background-color: #0000ff; border: 1px solid black;">B-5</td> <td style="background-color: #add8e6; border: 1px solid black;">ML</td> <td style="background-color: #d3d3d3; border: 1px solid black;">I-2</td> <td style="background-color: #c1e1c1; border: 1px solid black;">OPEN</td> <td style="background-color: #ffb6c1; border: 1px solid black;">T-3</td> <td style="background-color: #800080; border: 1px solid black;">T-5.2</td> </tr> <tr> <td style="background-color: #ffffff; border: 1px solid black;">R-1</td> <td style="background-color: #ff69b4; border: 1px solid black;">R-B</td> <td style="background-color: #d2b48c; border: 1px solid black;">T-B</td> <td style="background-color: #ff0000; border: 1px solid black;">B-3</td> <td style="background-color: #a9a9a9; border: 1px solid black;">CW</td> <td style="background-color: #008080; border: 1px solid black;">MH</td> <td style="background-color: #32cd32; border: 1px solid black;">PD</td> <td style="background-color: #ffcc99; border: 1px solid black;">SD</td> <td style="background-color: #d8bfd8; border: 1px solid black;">T-4</td> <td style="background-color: #4b0082; border: 1px solid black;">T-6</td> </tr> <tr> <td style="background-color: #ffff00; border: 1px solid black;">R-2</td> <td style="background-color: #ffcc99; border: 1px solid black;">H-B</td> <td style="background-color: #ff00ff; border: 1px solid black;">LB-2</td> <td style="background-color: #8b4513; border: 1px solid black;">B-4</td> <td style="background-color: #add8e6; border: 1px solid black;">MM</td> <td style="background-color: #9370db; border: 1px solid black;">I-1</td> <td style="background-color: #ffff00; border: 1px solid black;">MUN</td> <td style="background-color: #ff4500; border: 1px solid black;">SD-WH</td> <td style="background-color: #808080; border: 1px solid black;">T-5.1</td> <td></td> </tr> </table>				R-A	R-3	B-1	B-2	B-5	ML	I-2	OPEN	T-3	T-5.2	R-1	R-B	T-B	B-3	CW	MH	PD	SD	T-4	T-6	R-2	H-B	LB-2	B-4	MM	I-1	MUN	SD-WH	T-5.1	
R-A	R-3	B-1	B-2	B-5	ML	I-2	OPEN	T-3	T-5.2																								
R-1	R-B	T-B	B-3	CW	MH	PD	SD	T-4	T-6																								
R-2	H-B	LB-2	B-4	MM	I-1	MUN	SD-WH	T-5.1																									
								 NTS																									

SITE PLAN

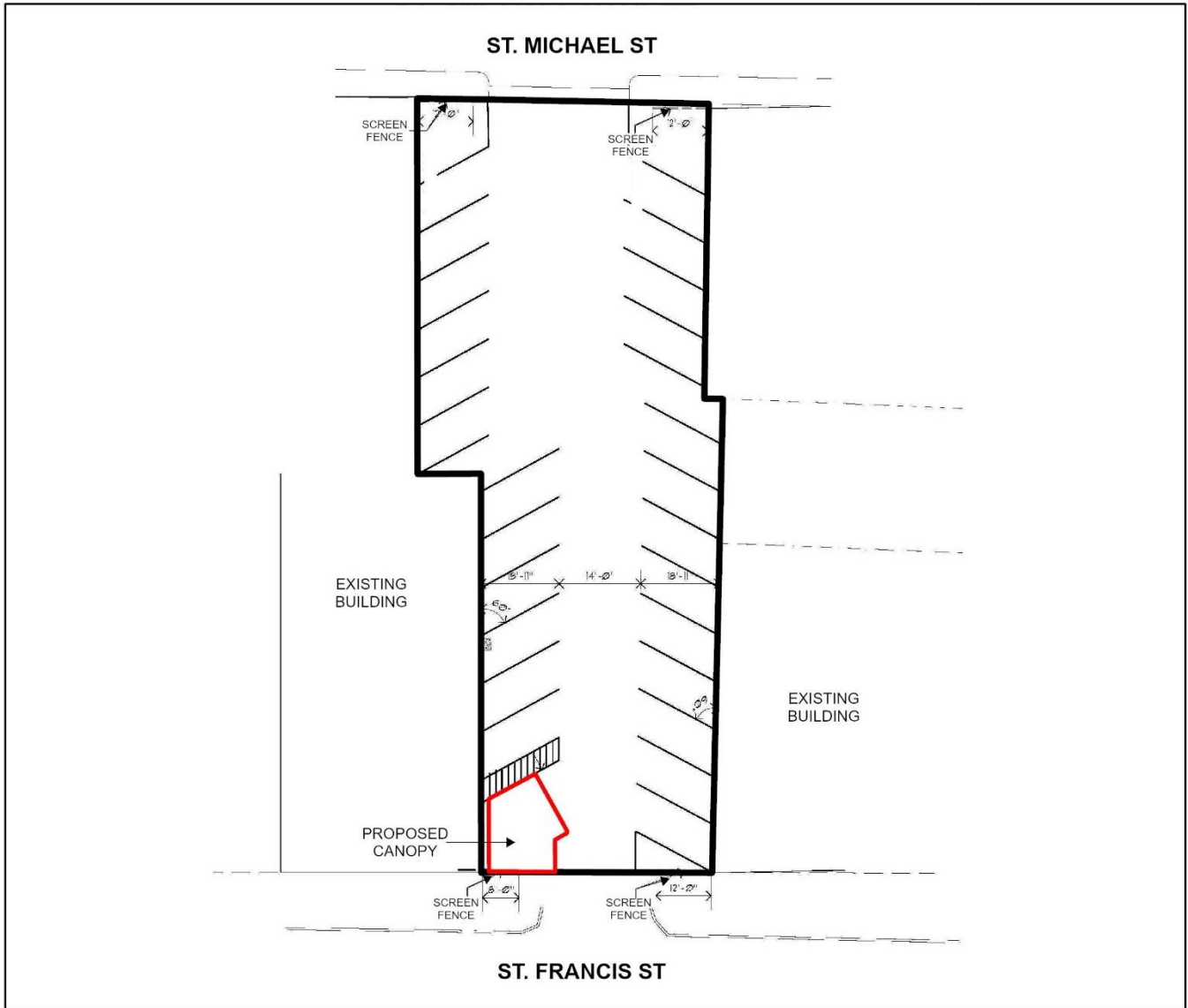

The site plan illustrates an existing parking area and the proposed canopy.

APPLICATION NUMBER <u>6565</u> DATE <u>January 8, 2024</u>	 NTS
APPLICANT <u>Jenny Olvera, Synovus</u>	
REQUEST <u>Frontage Type Variance</u>	

DETAIL SITE PLAN

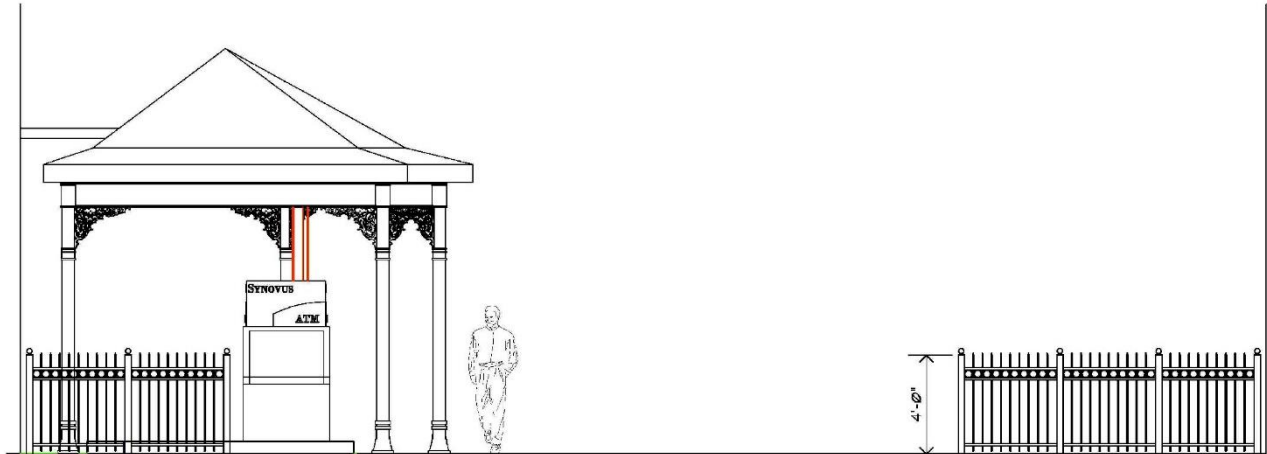

ST. FRANCIS ELEVATION
 $\frac{1}{2}'' = 1'-0''$

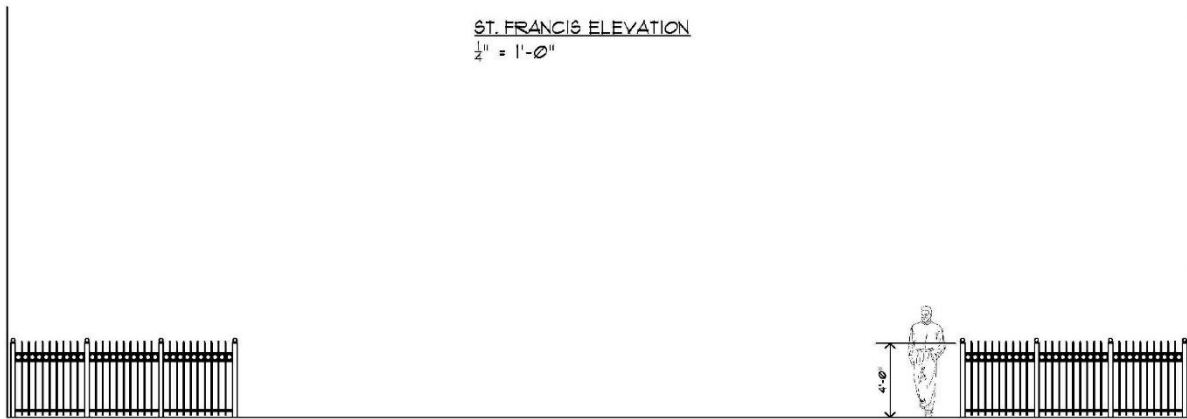

ST. MICHAEL ELEVATION
 $\frac{3}{8}'' = 1'-0''$

APPLICATION NUMBER <u>6565</u> DATE <u>January 8, 2024</u>	 NTS
APPLICANT <u>Jenny Olvera, Synovus</u>	
REQUEST <u>Frontage Type Variance</u>	

DETAIL SITE PLAN

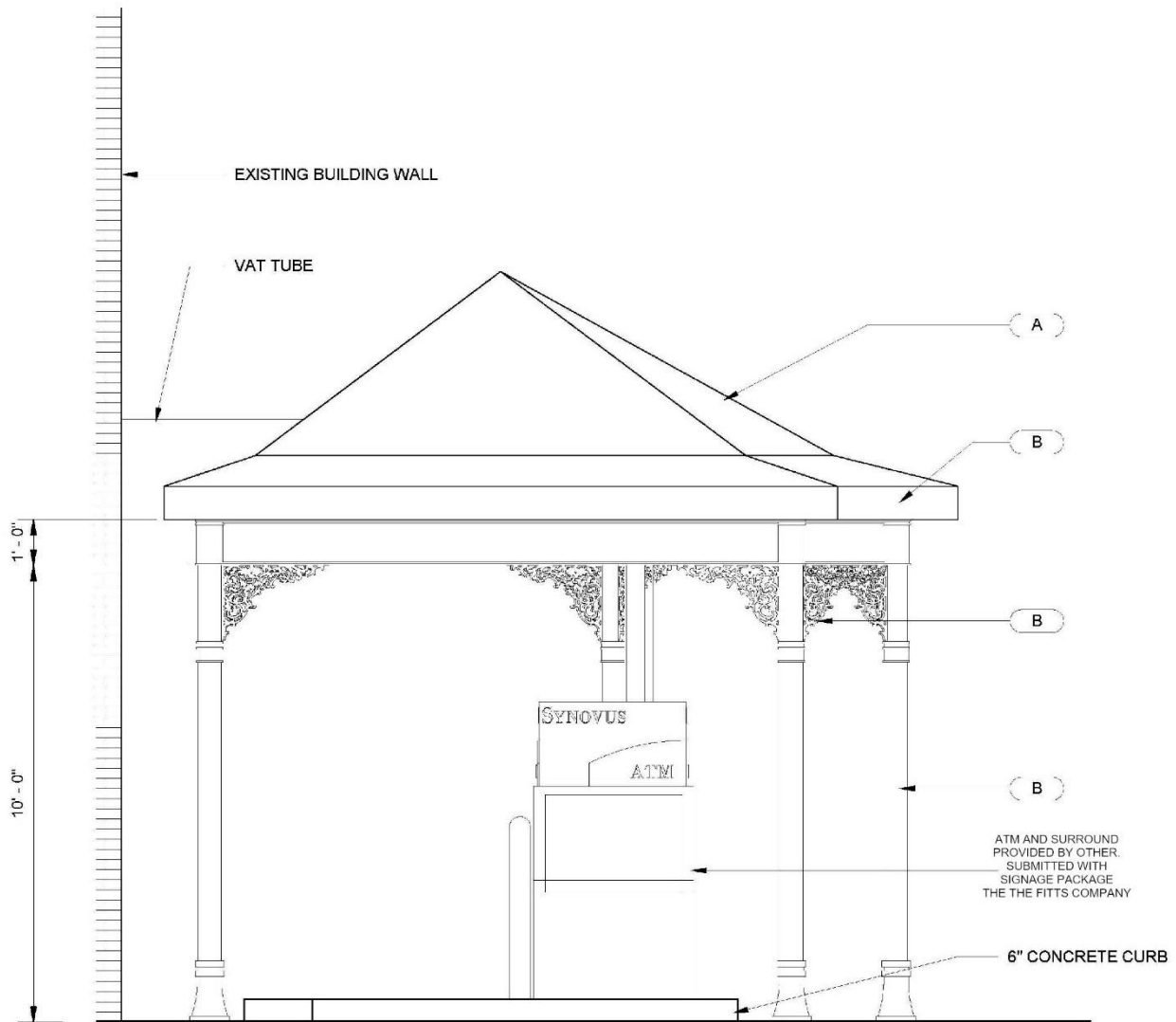

1 CANOPY SOUTH ELEVATION
R9 3/8" = 1'-0"

APPLICATION NUMBER 6565 DATE January 8, 2024

APPLICANT Jenny Olvera, Synovus

REQUEST Frontage Type Variance



DETAIL SITE PLAN

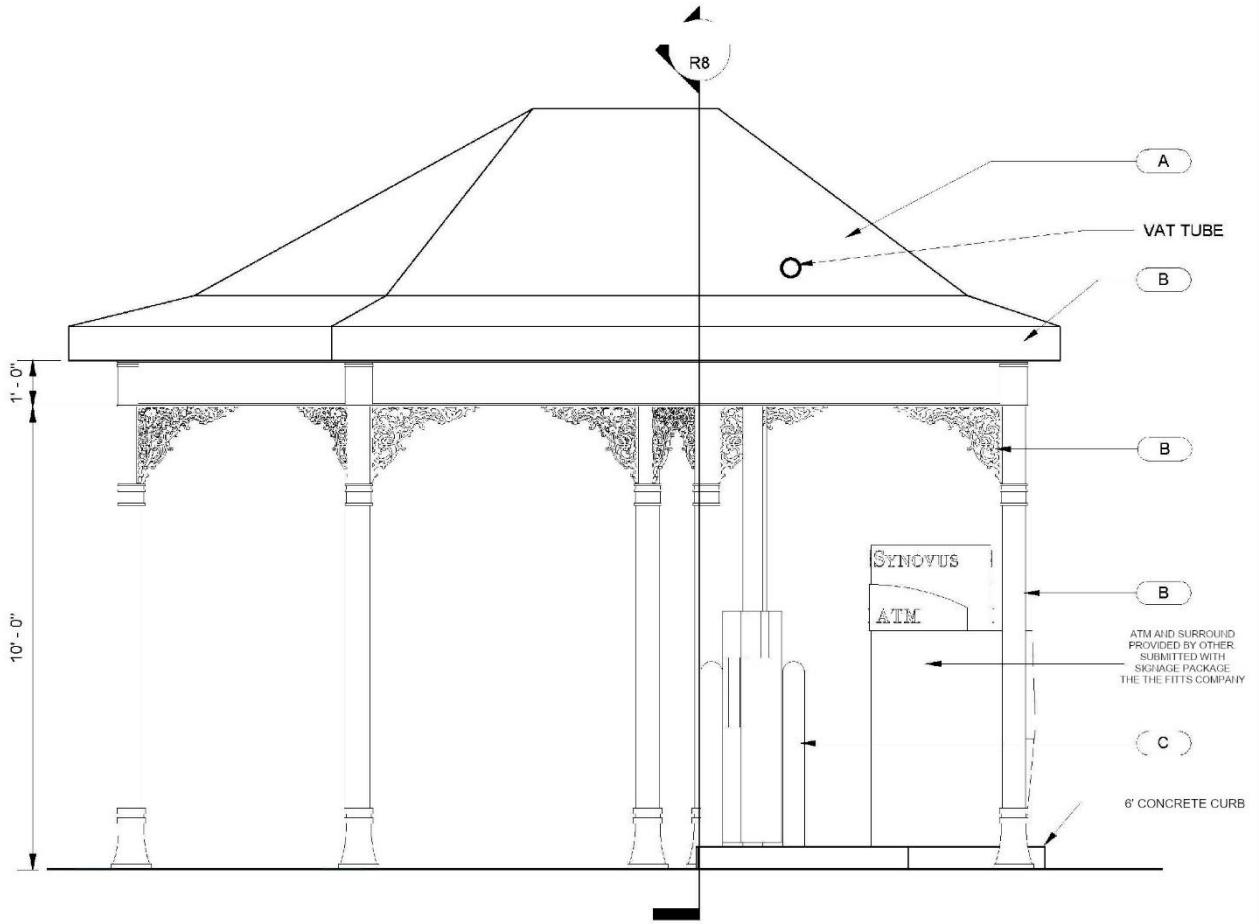

1 CANOPY WEST ELEVATION
R10 3/8" = 1'-0"

APPLICATION NUMBER	6565	DATE	January 8, 2024
APPLICANT	Jenny Olvera, Synovus		
REQUEST	Frontage Type Variance		



DETAIL SITE PLAN

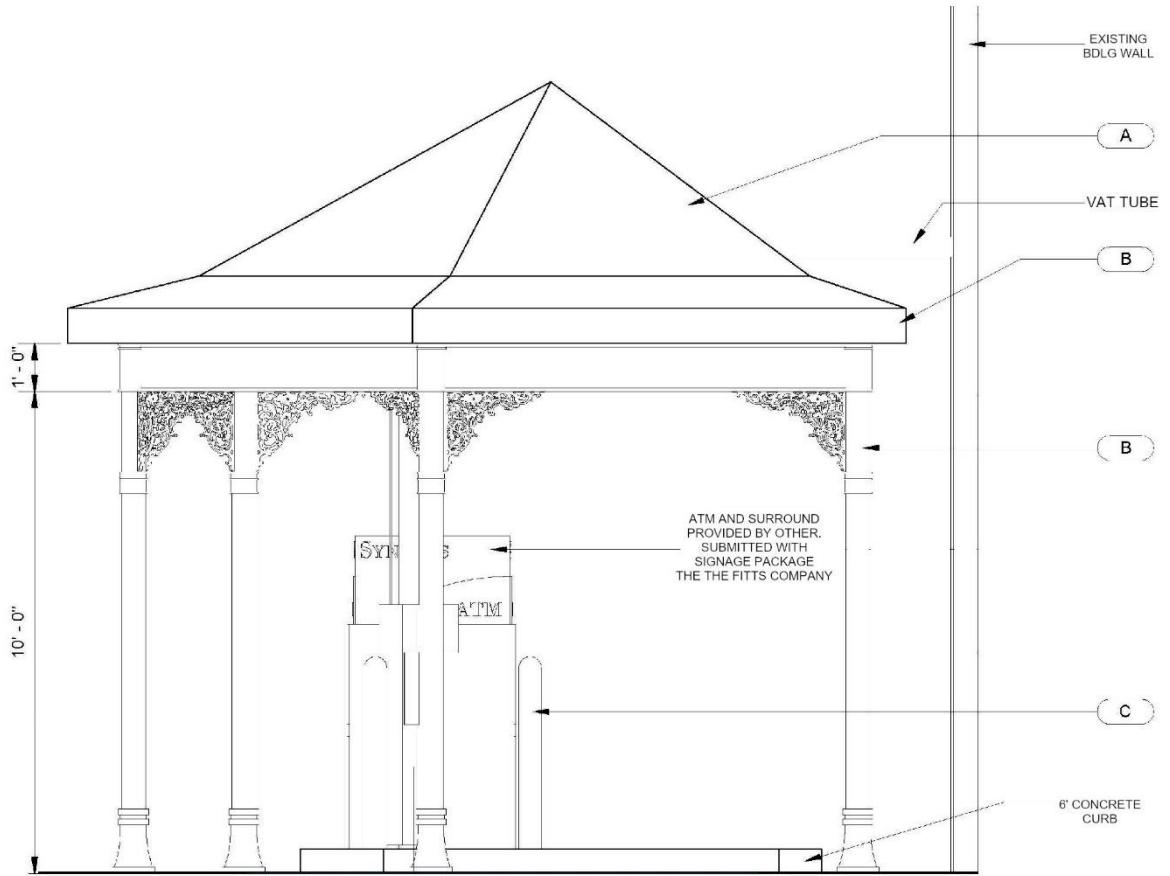

CANOPY NORTH ELEVATION
 1/23/24

APPLICATION NUMBER 6565 DATE January 8, 2024

APPLICANT Jenny Olvera, Synovus

REQUEST Frontage Type Variance



NTS

DETAIL SITE PLAN

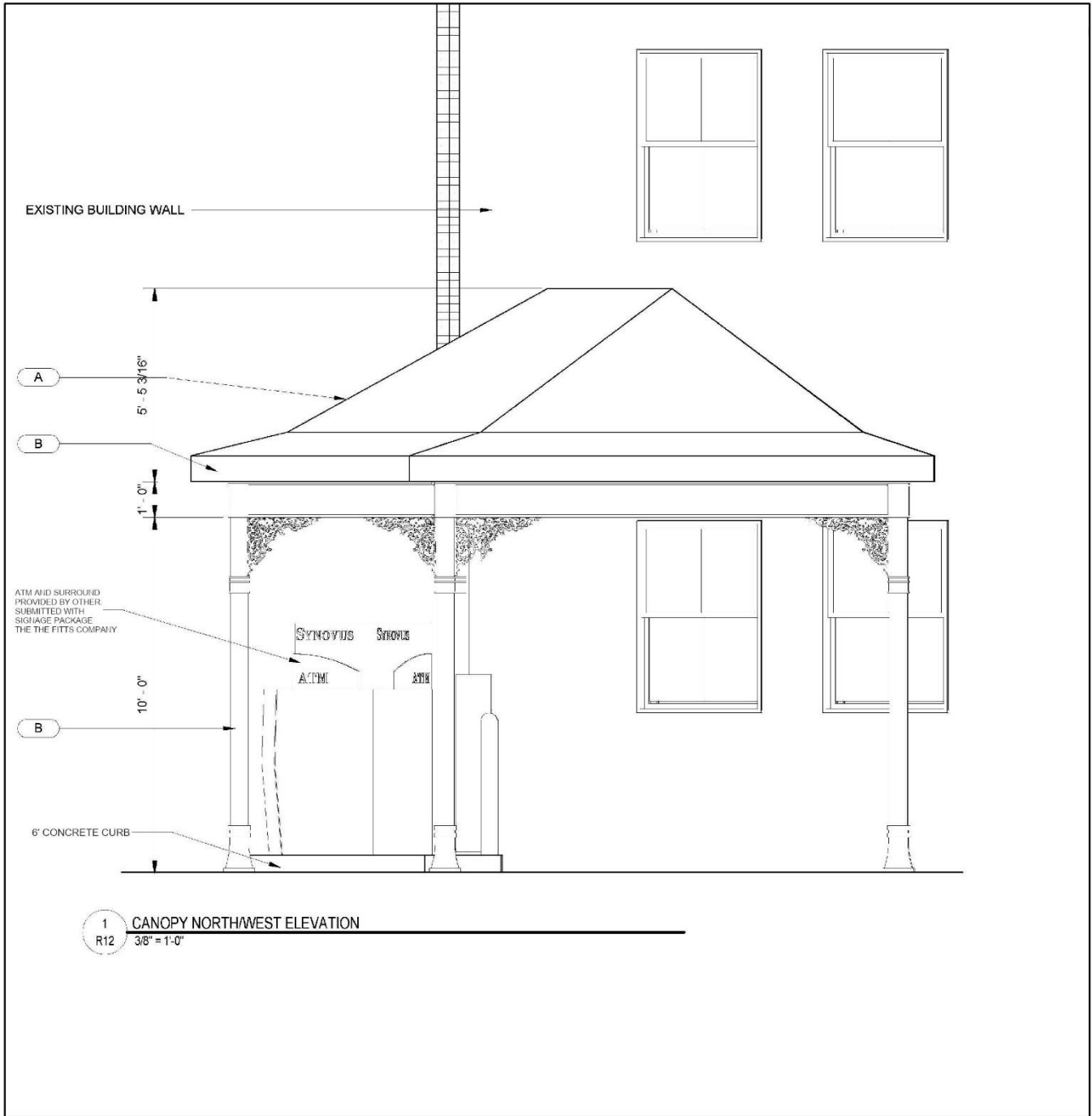

APPLICATION NUMBER 6565 DATE January 8, 2024

APPLICANT Jenny Olvera, Synovus

REQUEST Frontage Type Variance



DETAIL SITE PLAN

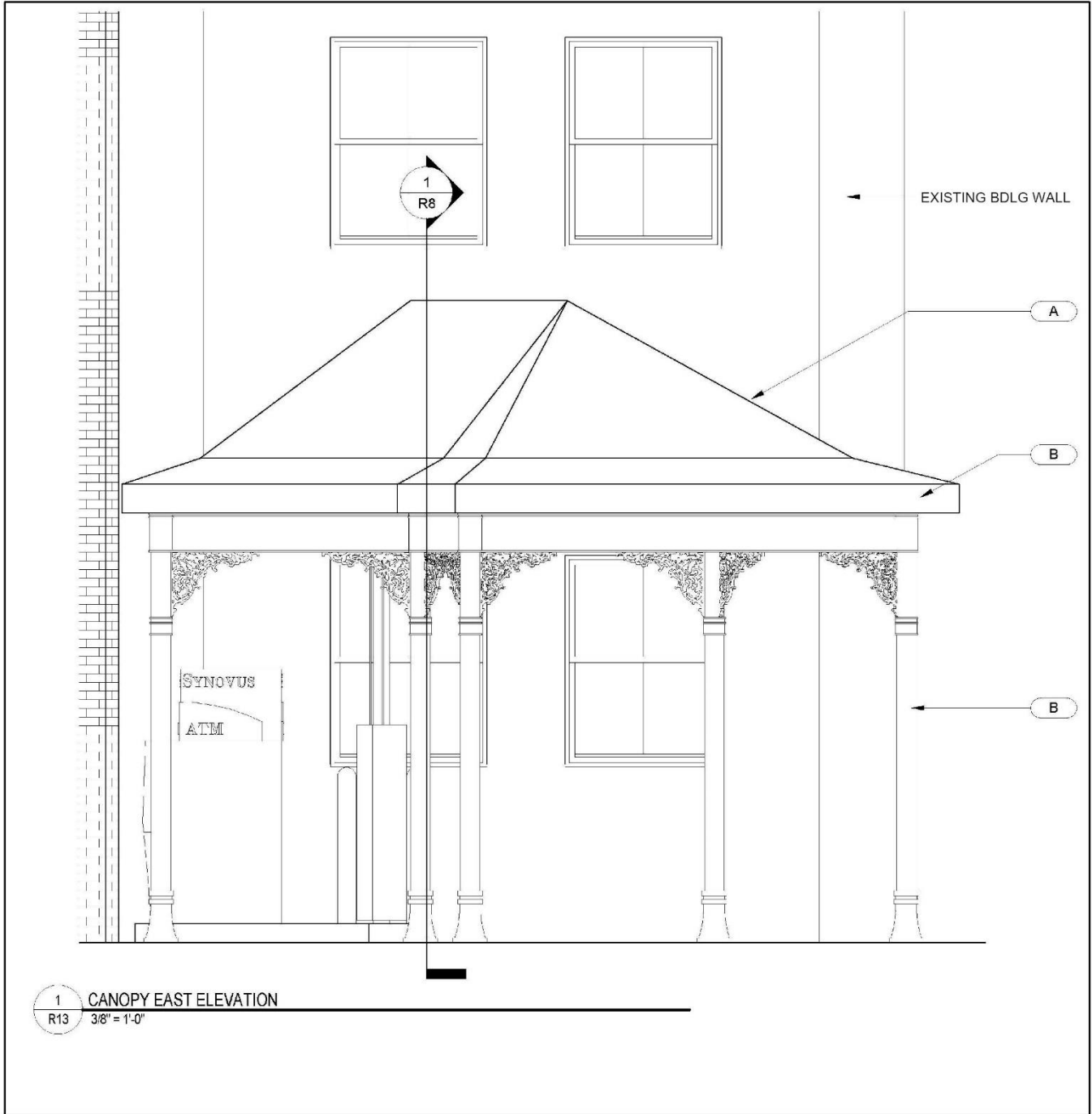

1 CANOPY EAST ELEVATION
R13 3/8" = 1'-0"

APPLICATION NUMBER 6565 DATE January 8, 2024

APPLICANT Jenny Olvera, Synovus

REQUEST Frontage Type Variance



NTS

DETAIL SITE PLAN

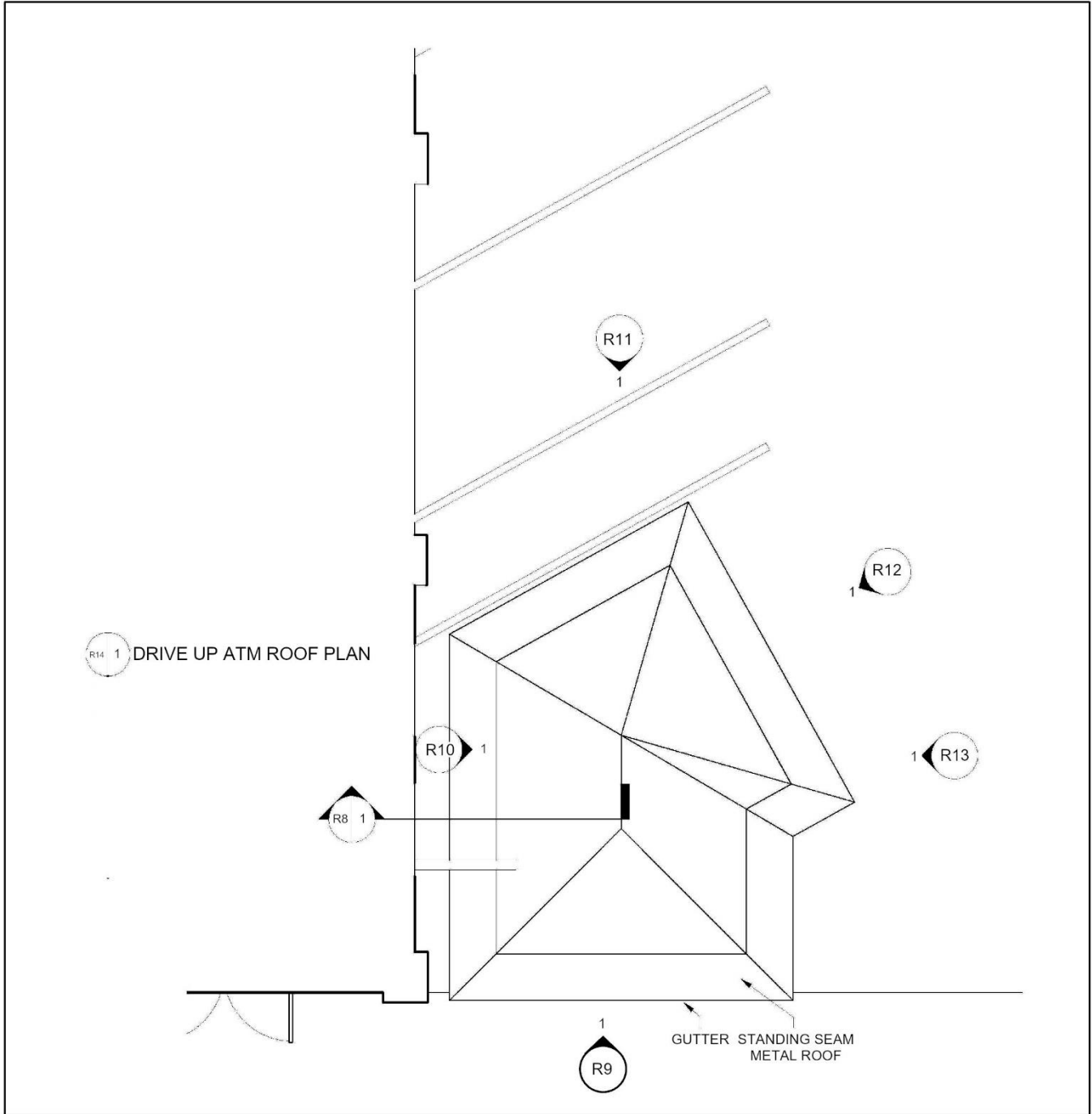

APPLICATION NUMBER 6565 DATE January 8, 2024

APPLICANT Jenny Olvera, Synovus

REQUEST Frontage Type Variance



DETAIL SITE PLAN



164 St. Frances St. South Rendering

APPLICATION NUMBER 6565 DATE January 8, 2024

APPLICANT Jenny Olvera, Synovus

REQUEST Frontage Type Variance



DETAIL SITE PLAN



164 St. Frances St. South East Rendering

APPLICATION NUMBER 6565 DATE January 8, 2024

APPLICANT Jenny Olvera, Synovus

REQUEST Frontage Type Variance



DETAIL SITE PLAN



164 St. Frances St. East Rendering

APPLICATION NUMBER	6565	DATE	January 8, 2024
APPLICANT	Jenny Olvera, Synovus		
REQUEST	Frontage Type Variance		



ZONING DISTRICT CORRESPONDENCE MATRIX		LOW DENSITY RESIDENTIAL (LDR)	MIXED DENSITY RESIDENTIAL (MXDR)	DOWNTOWN (DT)	DISTRICT CENTER (DC)	NEIGHBORHOOD CENTER - TRADITIONAL (NC-T)	NEIGHBORHOOD CENTER - SUBURBAN (NC-S)	TRADITIONAL CORRIDOR (TC)	MIXED COMMERCIAL CORRIDOR (MCC)	LIGHT INDUSTRIAL (LI)	HEAVY INDUSTRY (HI)	INSTITUTIONAL LAND USE (INS)	PARKS & OPEN SPACE (POS)	DOWNTOWN WATERFRONT (DW)	WATER DEPENDENT USES (WDWRLU)
RESIDENTIAL - AG	R-A														
ONE-FAMILY RESIDENCE	R-1	■				■		■					□		
TWO-FAMILY RESIDENCE	R-2	■				■		■					□	○	
MULTIPLE-FAMILY	R-3	○	■			■	■						□	○	
RESIDENTIAL-BUSINESS	R-B		○			■		■					□	○	
TRANSITIONAL-BUSINESS	T-B		○		■	■	■	■					□		
HISTORIC BUSINESS	H-B			■		■		■					□		
VILLAGE CENTER	TCD					■	■						□		
NEIGH. CENTER	TCD					■	■						□		
NEIGH. GENERAL	TCD					■							□		
DOWNTOWN DEV. DDD	T-6			■									□		
DOWNTOWN DEV. DDD	T-5.1			■		■		□					□		
DOWNTOWN DEV. DDD	T-5.2			■		■							□		
DOWNTOWN DEV. DDD	T-4			■		■		□					□		
DOWNTOWN DEV. DDD	T-3			■		■							□		
DOWNTOWN DEV. DDD	SD-WH									○	○		□		
DOWNTOWN DEV. DD	SD	○	○	○	○	○	○	○		○	○		□		
BUFFER BUSINESS	B-1		□			□	■	■	■				□	○	
NEIGH. BUSINESS	B-2		○			□	■	■	■				□	○	
LIMITED BUSINESS	LB-2		○			□	■	■	■				□	○	
COMMUNITY BUSINESS	B-3				■				■			○	□	○	
GEN. BUSINESS	B-4			■					■			○	□	○	
OFFICE-DISTRIBUTION	B-5								■	■			□	□	
LIGHT INDUSTRY	I-1									■			□	□	□
HEAVY INDUSTRY	I-2										■		□	□	□

Zoning District Correspondence Matrix

- Directly Related
- Elements of the zoning category are related to the future LU category, but with qualifications (such as a development plan with conditions)
- Land use category is appropriate, but the district does not directly implement the category (e.g., open space in an industrial district)

DOWNTOWN (DT)

Downtown is called out as a separate land use designation due to its distinct role, layout and fabric.

As a land use district, Downtown is the ultimate mixed-use environment. Land development and redevelopment will emphasize variety, mixed uses, and unity of form within buildings or complexes.

As the City's and region's center for commercial and service employment, Downtown supports intense development and a dynamic combination of uses: specialty and regional retail shopping and offices; business support services; urban housing at higher densities (starting at 10 du/ac); civic, educational and cultural destinations; entertainment options; and other public amenities including active and passive park space. The successful integration of a mix of housing types and densities will be critical to achieve a vibrant, 24/7, active Downtown Mobile.

Development in the DT district will focus on new, redeveloped and adaptively reused buildings that frame attractive, human-scaled streetscapes, memorable public spaces, bicycle and pedestrian-friendly streets and convenient transit access to jobs, housing and entertainment. Accordingly, certain areas of Downtown will be more intensively developed to facilitate that pedestrian orientation.